

# PRODUCT SHEET

## Description:

Alu Frame Hinge "B", Clip-On, 100DG, NPL, H=0, W/Plate F/ Wood Screws , Half-Overlay, W/SISO DK Name Plate, No Screws,, F/19-24mm Alu Frames, cc:28mm On Hinge Head

## Item number:

15.03.811-0

Units	Box	Carton	HS Code	Barcode
Pcs.	1	100	8302100090	 5704866103503

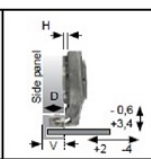
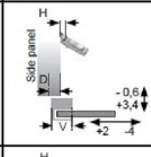
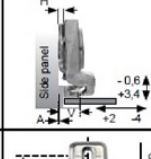
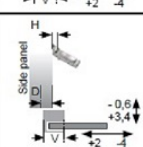
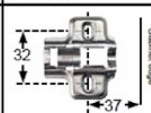

Steel - Nickel Plated		Item No.	D: Overlay calculations	A: Gap calculations																																
Full overlay (A)		15.03.810 Incl. SISO name plate + mounting plate H = 0	<table border="1"> <tr><th>D</th><th>V</th><th>19</th><th>20</th><th>21</th><th>22</th><th>23</th></tr> <tr><th>H</th><td>0</td><td>17</td><td>18</td><td>19</td><td>20</td><td>21</td></tr> <tr><td>2</td><td>15</td><td>16</td><td>17</td><td>18</td><td>19</td><td></td></tr> <tr><td>4</td><td>13</td><td>14</td><td>15</td><td>16</td><td>17</td><td></td></tr> </table>	D	V	19	20	21	22	23	H	0	17	18	19	20	21	2	15	16	17	18	19		4	13	14	15	16	17						
D	V	19	20	21	22	23																														
H	0	17	18	19	20	21																														
2	15	16	17	18	19																															
4	13	14	15	16	17																															
Half overlay (B)		15.03.811 Incl. SISO name plate + mounting plate H = 0	<table border="1"> <tr><th>D</th><th>V</th><th>19</th><th>20</th><th>21</th><th>22</th><th>23</th></tr> <tr><th>H</th><td>0</td><td>8</td><td>9</td><td>10</td><td>11</td><td>12</td></tr> <tr><td>2</td><td>6</td><td>7</td><td>8</td><td>9</td><td>10</td><td></td></tr> <tr><td>4</td><td>4</td><td>5</td><td>6</td><td>7</td><td>8</td><td></td></tr> </table>	D	V	19	20	21	22	23	H	0	8	9	10	11	12	2	6	7	8	9	10		4	4	5	6	7	8						
D	V	19	20	21	22	23																														
H	0	8	9	10	11	12																														
2	6	7	8	9	10																															
4	4	5	6	7	8																															
Inset (C)		15.03.812 Incl. SISO name plate + mounting plate H = 0	<table border="1"> <tr><th>A</th><th>V</th><th>19</th><th>20</th><th>21</th><th>22</th><th>23</th><th>24</th></tr> <tr><th>H</th><td>0</td><td>1,5</td><td>0,5</td><td>-0,5</td><td>-1,5</td><td>-2,5</td><td>-3,5</td></tr> <tr><td>2</td><td>3,5</td><td>2,5</td><td>1,5</td><td>0,5</td><td>-0,5</td><td>-1,5</td><td></td></tr> <tr><td>4</td><td>5,5</td><td>4,5</td><td>3,5</td><td>2,5</td><td>1,5</td><td>0,5</td><td></td></tr> </table>	A	V	19	20	21	22	23	24	H	0	1,5	0,5	-0,5	-1,5	-2,5	-3,5	2	3,5	2,5	1,5	0,5	-0,5	-1,5		4	5,5	4,5	3,5	2,5	1,5	0,5		
A	V	19	20	21	22	23	24																													
H	0	1,5	0,5	-0,5	-1,5	-2,5	-3,5																													
2	3,5	2,5	1,5	0,5	-0,5	-1,5																														
4	5,5	4,5	3,5	2,5	1,5	0,5																														
		H = 0 f/chipboard screws Clip-on	Delivered as standard mounting plate with all hinges. Chipboard screws to be ordered separately.																																	

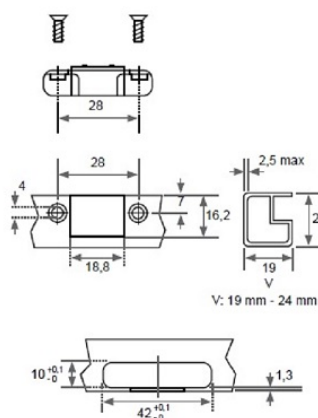

Opening angle:	100°
Mounting of hinge: Screw - on c.c.	28 mm
Width of aluminium frame (V):	19-24 mm

## SISO A/S

Mileparken 11  
DK-2740 Skovlunde  
Denmark  
VAT: DK 24786013

Phone +45 45 830 900

www.siso.dk  
siso@siso.dk

Danske Bank  
Nytrov Branch  
Copenhagen  
SWIFT: DABADKKK

Account no.  
4180 3112 112936  
IBAN Account  
DK7230003112112936